

# ECOFLOW

## User Guide

# EF DELTA

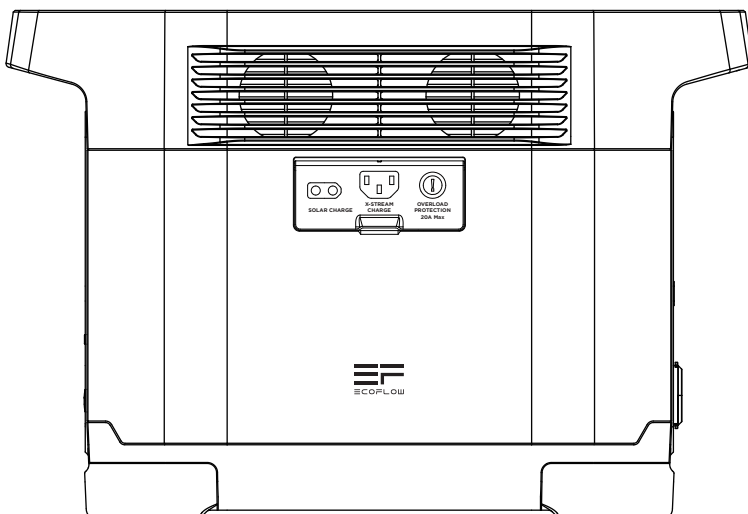

**WARNING**

1. Keep EF DELTA and the accessories dry and do not expose them to high heat.
2. Never disassemble, puncture, shock, crash, or incinerate the product or the accessories.
3. Recycle and dispose of EF DELTA in accordance with the local regulations.
4. Pay attention to safety when handling the EF DELTA.
5. People with disabilities or children should use the machine under the protection of the supervisor.

**Contact us:**

[support@ecoflow.com](mailto:support@ecoflow.com)

[www.ecoflow.com](http://www.ecoflow.com)

# GLOSSARY

The following terms are used in this document to indicate various levels of potential harm that may be caused by improper operation.

## NOTICE

The instructions, if not properly followed, may result in property damage and minor physical damage.

## CAUTION

The instructions, if not properly followed, may result in property damage and serious physical damage. The instructions, if not properly followed, may result in property damage and serious physical damage.

## WARNING

The instructions, if not properly followed, may result in property damage, major accident and serious injury.

### WARNING

Read the **ENTIRE** user manual to be familiar with the features of this product before operating. Failure to operate the product correctly may result in damage to the product or personal property and cause serious injury. EcoFlow will not assume any legal responsibility. **DO NOT** use the product with incompatible components or alter the product in any way without following the instructions provided by EcoFlow. Otherwise, you cannot get after-sales service from EcoFlow under warranty condition. These Safety Guidelines include instructions for safety, operation and maintenance. It is important to read and follow all the instructions and warnings in the user manual before assembly, setup or use the product.

# PRODUCT SAFETY GUIDELINES

### WARNING

Improper use may result in fire, property damage or personal injury. Make sure to use the product according to the following safety rules and guidelines.

## Product use:

1. Do not expose EF DELTA to any liquid. Keep the EF DELTA away from rain or any liquid. Do not drop the EF DELTA into the water. If the battery in the EF DELTA comes into contact with water, it may cause chemical decomposition of the battery. This may cause the battery to catch fire or explode.
2. Never use NON- EcoFlow batteries. EcoFlow takes no responsibility for any damage caused by non-EcoFlow batteries.
3. Never use or charge swollen, leaky, or damaged batteries. If your battery is abnormal, contact EcoFlow support or a EcoFlow authorized dealer for further assistance.
4. Never install or remove a battery from the RIVER/EF DELTA when it is turned on.
5. **DO NOT** use the batteries in strong electrostatic or electromagnetic environments. Otherwise, the battery control board may malfunction and cause a serious accident during use.

6. Never disassemble or pierce the product in any way. Otherwise, it may leak, catch on fire, or explode.
7. DO NOT use the product if it was involved in a crash or a heavy bump.
8. If the product falls into the water during use, take the product out immediately and put it in a safe and open area. Keep a safe distance from it until it is completely dry. Never use it again and dispose it properly as described in the Battery Disposal section below. If the product catches fire, it is recommended to use fire extinguishing equipment in the following order: water or water mist, sand, fire blanket, dry powder, carbon dioxide fire extinguisher.
9. DO NOT put the machine in a microwave oven or in a pressurized container.
10. Do Not allow pins, wires or other metal pieces to insert to the device case, outlets or controls. Metal pieces may short circuit the product.
11. Avoid collision. DO NOT place heavy objects on the machine.
12. If there is dirt on any plug or outlet surface, use a dry cloth to clean it. Otherwise, it will cause abrasion and result in energy loss or inability to charge.

## **WARNING**

### **Product Charging:**

1. Always use EcoFlow approved charging cables. EcoFlow takes no responsibility for any damage caused by using non-EcoFlow charging cable.
2. When charging, please place the product on the ground with no flammable or combustible materials around. To prevent accidents, never leave the machine unattended during charging.
3. DO NOT charge a product immediately after a long heavy load, because the product's temperature may be too high. DO NOT charge a product until it cools down to room temperature. The product may be unable to charge out of the temperature range -4°F to 140°F (-20 to 60°C). The ideal charging temperature range is 71°F to 82°F (22°C to 28°C).

### **Product Storage and Transportation:**

1. Keep the product out of the reach of children. If any children accidentally swallow parts, please go to a doctor immediately.
2. If a low-battery warning appears, charge the battery before store it. Otherwise, long-term storage may cause damage to the battery in the product. Batteries in the product will enter hibernation mode if it is depleted and stored for a long time. Recharge the product can bring the battery out of hibernation.
3. DO NOT place the product near a heat source, such as a car in direct sunlight, a fire source, or a heating stove.
4. Store the product in dry environments. DO NOT place the product where it may contact with water.
5. Make sure no small metal objects can fall on or around the product while in storage.
6. Never transport a product with a battery power level higher than 30%.

### **Battery Disposal:**

1. Dispose the product in specific recycling boxes only after a complete discharge. Batteries are hazardous chemicals. Please strictly follow your local regulations regarding the battery disposal and recycle.
2. Dispose of the product immediately if it cannot be powered on after over-discharging.

### **Product Maintenance:**

1. Never store the product in environments below -20°C or above 60°C.
2. Battery life may be reduced if not used for a long time.
3. Fully charge and discharge the battery at least once every 3 months to maintain battery health.

### **Travel Notice:**

It is forbidden to carry lithium batteries and equipment with a capacity greater than 160Wh on airplane due to the regulation; Do Not bring this product on flights..

## FCC STATEMENT

**This device complies with Part 15 of the FCC Rules. Operation is subject to the following two conditions:**

- (1) This device may not cause harmful interference, and**
- (2) This device must accept any interference received, including interference that may cause undesired operation.**

### **WARNING**

**Changes or modifications not expressly approved by the party responsible for compliance could void the user's authority to operate the equipment.**

### **NOTICE**

This equipment has been tested and found to comply with the limits for a Class B digital device, pursuant to Part 15 of the FCC Rules. These limits are designed to provide reasonable protection against harmful interference in a residential installation. This equipment generates uses and can radiate radio frequency energy and, if not installed and used in accordance with the instructions, may cause harmful interference to radio communications. However, there is no guarantee that interference will not occur in a particular installation. If this equipment does cause harmful interference to radio or television reception, which can be determined by turning the equipment off and on, the user is encouraged to try to correct the interference by one or more of the following measures:

1. Orient or relocate the receiving antenna.
2. Increase the separation between the equipment and receiver.
3. Connect the equipment into an outlet on a circuit different from that to which the receiver is connected.
4. Consult the dealer or an experienced radio/TV technician for help.

## FCC RADIATION EXPOSURE STATEMENT

**This equipment complies with FCC radiation exposure limits set forth for an uncontrolled environment. This equipment should be installed and operated with minimum distance 20cm between the radiator & your body.**

# CONTENTS

EF DELTA USE CARE AND SAFETY GUIDE -----	1
FEATURES of EF DELTA -----	2
LCD DISPLAY -----	4
SOLAR PANEL CONNECTION -----	8
ENTRY-LEVEL UPS AND SERIES MODE -----	9
TECHNICAL SPECIFICATIONS -----	11
HOW TO RECHARGE EF DELTA -----	12
FAQs -----	12
WHAT'S IN THE BOX -----	13
OPTIONAL -----	13

# EF DELTA USE CARE AND SAFETY GUIDE

## CONGRATULATIONS!

You now own the best quality Portable Battery Generator in the world. This pamphlet is short and is meant to help you. Please take some time to read it before using the product.

## NOTICE

**Please note:**

**To turn ON/OFF EF DELTA, you need to PRESS & HOLD the Power Button. To turn on the AC power outlet, you need to PRESS & HOLD the AC Button after turning on EF DELTA.** This is designed purposefully: it will save the battery life, so that your EF DELTA's power is available when you need it.

## Battery Maintenance:

Get to know your EF DELTA. Follow this step-by-step introduction to each of EF DELTA's ports, buttons, display screens and more.

## Technical Specifications:

Understanding the specs that make EF DELTA such a cutting-edge product.

## How to Charge EF DELTA:

Everything you need to know about recharging your EF DELTA via AC Cable, car charge cable or solar charge cable (if applicable).

## FAQs:

Answers to you some of the most important questions about how to take care of your EF DELTA, store your EF DELTA, and safely use your EF DELTA.

## What's in the Box:

What include in your EF DELTA purchase. If your purchase does not include these items, please contact us at [support@ecoflow.com](mailto:support@ecoflow.com).

# FEATURES OF EF DELTA

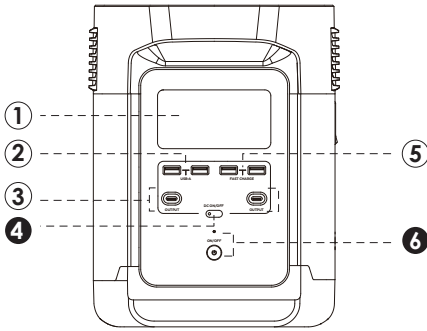

1. LCD Display
2. USB-A Output Ports
3. USB-C Output Port
4. **DC ON/OFF Switch**  
(PRESS & HOLD to switch ON/OFF)  
**DC Output Indicator**
5. Fast Charge USB-A Output Ports
6. **Power ON/OFF Button**

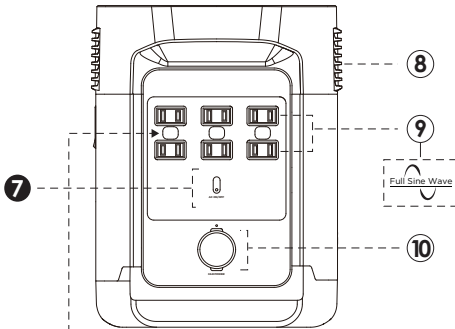

7. **AC ON/OFF Switch**  
(PRESS & HOLD for ON/OFF)  
**AC Output Indicator Light**
8. Ventilation Vents
9. 6 AC Output Sockets (100-120V)  
4 AC Output Sockets(International  
Version 220-240V)
10. Car Outlet  
Car Outlet Indicator

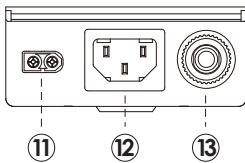

11. Solar Charge/Car Charge Input Port
12. X-STREAM AC Charging Input Port
13. Overload Protection Switch

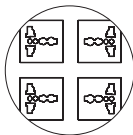

## 220-240V\* Dedicated AC Output

\*EcoFlow has designed different AC Output sockets following the local regulations of different countries.

## 1. LCD Display

Displays the various conditions of the product. The screen will turn off after 5 mins. You can turn it on by pressing ON/OFF button.

## 2. USB-A Output Ports

Charge a wide array of devices such as your iPhone, tablet, GoPro, speakers, or anything that needs to be charged through a USB-A Port. The USB-A Output Indicator Light will automatically light up when a USB-A port is in use.

### 3. USB-C Output Ports

Devices that charge through a USB-C port, such as a MacBook Pro, Android phone, or other devices can be charged by the EF DELTA USB-C port. The USB-C Output icon will appear on LCD Display when a USB port is in use.

### 4. DC ON/OFF Switch (PRESS & HOLD to switch ON/OFF) & DC Output Indicator

Press DC ON/OFF to turn on or off EF DELTA DC power. The DC **ON/OFF** button controls the EF DELTA's DC output. EF DELTA could not recognize when low-power devices, such as earphone, is charging. So EF DELTA is designed to keep the DC power on for 24 hours. The DC power will go off after 24 hours of not using it. If you want to extend your standby time to 24 hours, turn the DC button on.

### 5. Fast Charge USB-A Output Ports

The USB-A Output Indicator Light will automatically light up when a USB-A port is in use. Fast charge-enabled devices can be charged at a maximum speed of 28W. If your device does not support fast charging, the device will charge in regular speed.

### 6. Power ON/OFF Button

Press and hold the power button to turn EF DELTA on or off. When EF DELTA is turned on the LCD Display Screen will light up. To turn **ON/OFF** LCD Display Screen and keep EF DELTA working, press the Power Button. The Power Indicator Light will automatically light up when EF DELTA senses any of the output ports is in use. The Power Indicator Light will flash when none of EF DELTA's output ports is in use, meaning EF DELTA is in the Idle State. After 5 minutes' in the Idle State, EF DELTA's screen will enter into the sleep mode( the battery is still running). After 30 mins of not using in Idle State, EF DELTA will automatically shut down to protect its batteries.

### 7. AC ON/OFF Switch (PRESS & HOLD for ON/OFF)

The AC power button controls the AC output of the EF DELTA. The AC power needs to be turned on manually. To enable AC power, press the AC power button. When AC power is not in use to charge a device, press the AC power button to turn off the AC power. Make sure to unplug the power cord from the AC port. When the AC power of the EF DELTA is enabled, the AC indicator will light up. If the AC power is not used for more than 12 hours, the product will turn off automatically. In addition, for users in selected countries, please press and hold AC ON/OFF for 15s to switch between 50 and 60Hz.

### 8. Ventilation Fans

The fans prevent EF DELTA from overheating.

### 9. 6 AC Output Sockets (100-120V reigon) / 4 AC Output Sockets(International Version 220-240V)

Charging devices that require 100-120V AC (230V for 220-240V edition) wall chargers to be charged, such as laptops, TVs, mini refrigerators, vacuums etc.,

### 10. Car Outlet & Car Outlet Indicator

Charging devices that need car ports to be charged, such as drone batteries. The Car Outlet Indicator Light will automatically light up when the car port is in use.



## 11. Solar Charge/Car Charge Input Port

Supports a maximum of three 110W solar panels to be connected in series. Do not put more than two solar panel for parallel connection. EF DELTA has a limit input of 400W. Supports car charge with a maximum input of 10A.

## 12. X-STREAM AC Charging Input Port

Plug in an AC cable with a universal three-pin plug (one that can withstand an effective current of 15A) into the port and connect the cable to an AC power source. Please note that U.S. and Japan versions only support chargings in 100-120Vac (50/60Hz). International version supports 220-240Vac (50/60Hz) EF DELTA's X-STREAM system supports entry-level UPS function, user can use the EF DELTA AC socket while the device is connected to a wall socket with AC power supply (the AC power comes from the grid, not the battery). When the grid loses power suddenly, the device can automatically switch to EF DELTA battery power mode in  $\leq 30$ ms to ensure your work is not interrupted. This is an entry-level grade UPS function that does not support 0ms switching.

**Do not connect devices with high uninterrupted power supply requirements. Please perform multiple tests to confirm compatibility before connecting devices, such as data servers and workstations to EF DELTA. EcoFlow will not be responsible for any loss of data or equipment damage caused by customers' failure in following the instruction.**

## 13. Overload Protection Switch

When the input current continuously exceeds 20A during a charge, the AC charging port will trigger the overload protection (the Overload Protection Switch icon will automatically pop out). When the device is confirmed to be in normal status, press the overload protection switch button to continue charging.

## LCD DISPLAY

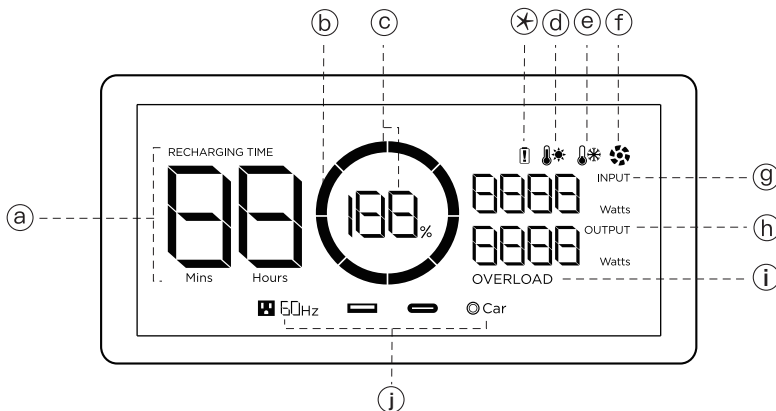

### a. Remaining Charge Time

The number indicates the remaining charge/discharge time (in minutes) for EF DELTA.

## b. Battery Failure Warning

If the circle icon on EF DELTA's display screen is flashing, please contact our Product Experts at support@ecoflow.com.

## c. Battery Level Indicator

Shows the percentage of the power. If it displays 0%, please charge EF DELTA immediately.

## d. High Temperature Indicator

When the temperature of the EF DELTA is too high, a high-temperature warning icon appears on the screen to warn that the temperature of the product is too high. Please cool down the product before use it again .

## e. Low temperature indicator

A low-temperature warning icon appears on the screen to warn that the temperature of the EF DELTA is too low. Please move the product to a warm place and wait until it turns to working temperature before use it.

## f. Fan indicator

The EF DELTA fan speed is intelligently controlled by the EF DELTA , and the displayed speed is related to the fan speed.

## g. Current Input

Shows the current input power of EF DELTA in watts.

## h. Current Output

Shows the current output power of EF DELTA in watts.

## i. Overload Warning

There are two types of overload protection. **The first type protection:** in the DC area, when any port is powering devices that exceed maximum current limit, or the output power of the AC jack exceeds the maximum AC power output (Overload 1%-10% will work 3mins overload 11%-30% will work 1min; overload 31%-49% will work 1s; overload 50%-100% will work 100ms), and when the vehicle power supply output exceeds the maximum current, the overload indication and the corresponding interface indicator will flash simultaneously for 15 seconds. The output of the interface will be automatically shut down immediately, and other ports will continue to work.













**Second type of protection:** When the power output from the DC or AC jack, and the vehicle power outlet exceeds the battery maximum power output, the overload indicator and the corresponding port indicator will flash simultaneously for 15 seconds. EF DELTA will automatically shut down immediately. After an overload occurs, remove the overloaded device first, and then restart EF DELTA to resume work.







## j. Port Usage Indicators

Indicates the usage status of each port. In addition, press and hold the AC **ON/OFF** button for 15s to switch from 50Hz to 60Hz, vice versa.

## \*. Protection Information Instruction

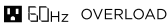
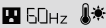
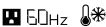
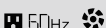
The EF DELTA display screen uses different icons and combined icons to indicate different protections for the product.

 OVERLOAD	<b>USB-A Overload Protection</b>	USB-A and OVERLOAD icons flash together. Disconnect all electrical appliances and wait 10 seconds before adding each appliance back.
	<b>USB-C High Temperature Protection</b>	USB-C and High-Temperature icons flash together. Let product cool before connecting each appliance back.
OVERLOAD	<b>Product Overload</b>	Overload icon flashes. Unplug all the electrical devices and restart the product
RECHARGING TIME  	<b>High Temperature Discharge-protection</b>	RECHARGING TIME, Exclamation and High-temperature icons flash together. This happens usually after a heavy battery use. Let EF DELTA cool down before recharging it.
 	<b>High Temperature Recharge-protection</b>	Exclamation and High-temperature icons flash together. The power supply can be resumed after battery is cooled down.
RECHARGING TIME  	<b>Low Temperature Recharging-protection</b>	RECHARGING TIME, Exclamation and Low-temperature icons flash together. Place EF DELTA in a warmer place and wait for it back to its working temperature before recharging it.
 	<b>Low Temperature Discharge-protection</b>	Exclamation and Low-Temperature icons flash together. Place EF DELTA in a warmer place and wait for it back to its working temperature before recharging it.
RECHARGING TIME  OVERLOAD	<b>Overload Recharging-protection</b>	RECHARGING TIME, Exclamation and OVERLOAD icons flash together. Unplug Charging cables, restart EF DELTA and plug back in, If light keeps flashing contact support@ecoflow.com
 OVERLOAD	<b>Overload Discharging-protection</b>	Exclamation and OVERLOAD icons flash together. Disconnect all appliances, restart EF DELTA, and plug each appliance back in turn. Please note that electrical appliances must be operated within rated power.

	<b>Communication Failure between Main Board and BMS</b>	Only the Exclamation icon is flashing. Restart EF DELTA. If the light keeps flashing, contact support@ecoflow.com
	<b>Battery Cells Failure</b>	The Exclamation icon is on. Try to restart the device. If the light keeps flashing, please contact our product specialists via support@ecoflow.com.
	<b>Communication Failure between Main Board and AC</b>	AC icon flashes. Restart EF DELTA. If the icon keeps flashing, contact support@ecoflow.com.
	<b>Inverter Output Overload</b>	AC and OVERLOAD icons flash together. Wait 10 seconds, turn AC Power ON/OFF. Please note that electrical appliances must be operated within rated power.
	<b>Inverter High Temperature Protection</b>	AC and High-temperature icons flash together. Let EF DELTA cool down. Then turn AC Power On/OFF the interface will automatically resume operation.
	<b>Inverter Low Temperature Protection</b>	The AC and Low-Temperature icons flash together. Move EF DELTA to a warmer place and wait for the inverter to warm up
	<b>Fan Blockage</b>	AC and Fan icon flashes. Turn off EF DELTA and carefully clean and vacuum around vents on both sides. Turn System Power On. If icon keeps flashing contact support @ecoflow.com.
	<b>Car Charger Overload</b>	Car and OVERLOAD icons flash together. Restart EF DELTA, and make sure that electrical appliances must be operated within rated power.
	<b>Car Charger High Temperature Protection</b>	Car and High-temperature icons flash together. When temperature/XT60 Interface is recharging in a High Temperature. Wait for EF DELTA to cool down and it will automatically recover.
	<b>Communication Failure between Main Board and MPPT</b>	Car icon flashes. Try to restart the device. If the icon keeps flashing, please contact our product specialists via support@ecoflow.com.

# SOLAR PANEL CONNECTION

## How to recharge the EF DELTA with solar panels?

If you need to know more about the connection of a single panel, please refer to Solar Panel User Manual. Here we focus on demonstrate how serial connection (up to three panels and the parallel connection of up to six panels). EF DELTA supports 10-65V DC input. When the input exceeds 65V, EF DELTA overload protection will be triggered. Voltage excessive may damage the product. Users should follow all the instructions in the manual. EcoFlow do not provide free repair services for any product damage caused by connecting many solar panels to the product or incorrect connection, even during the warranty period.

### 1. Recommended serial connection method

- Users can connect 1 to 3 pieces of solar panels (do not connect more than 3 in series) in series as shown in the figure below, to the MC4 port.
- Then, connect to MC4 to XT60 conversion cable.
- Use XT60 conversion port connect to the XT60 port on EF DELTA.

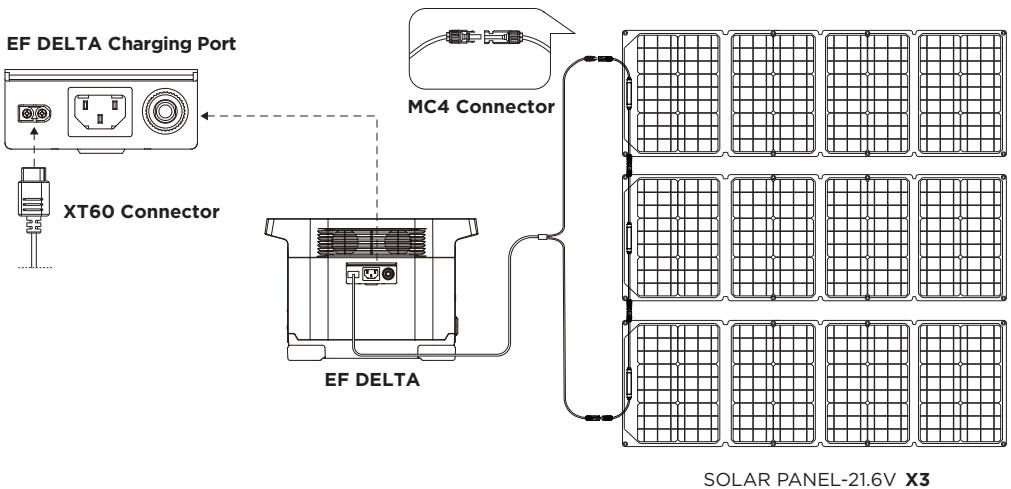

### 2. Serial and parallel connection (Professional solution)

Users can connect up to 2 sets of solar panels in parallel to the MC4 port as shown in the figure. If you want to connect 6 solar panels, you can put them into 2 sets of 3 solar panels connected in series and then connect the 2 sets of solar panels in parallel. Connect them with our MC4 to XT60 conversion cable and connect XT60 cable to the EF DELTA's XT60 input to charge the device. The parallel connection cable is an optional accessory needs to be purchased separately.

### EF DELTA Charging Port

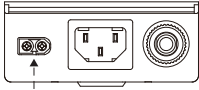

XT60 Connector

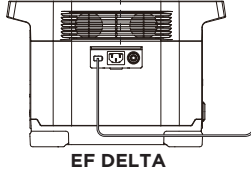

EF DELTA

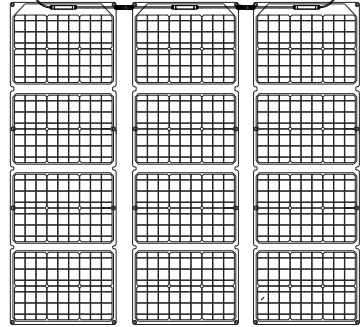
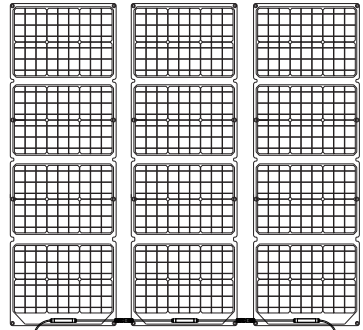

SOLAR PANEL-21.6V X6

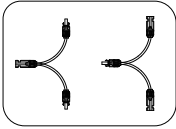

### Solar MC4 parallel connection cable

\* Users have to buy the solar panels and other parallel connection accessories separately.

## 3. EF DELTA supports the use of third party solar panels (DIY solution)

Users can buy universal solar panels of MC4 connection standard on their own to power EF DELTA, as long as the voltage and current (10-65V DC, 10A max) comply with the specifications of EF DELTA, the panels will be able to recharge EF DELTA through the MC4 to XT60 conversion cable.

**Note: EcoFlow do not provide free repair services for any damage to the product caused by the quality issue or improper operation of the third-party solar panels, even in the warranty period.**

## ENTRY-LEVEL UPS AND SERIES MODE

### Precautions when using EF DELTA UPS and series mode

When EF DELTA has UPS or series mode on, EF DELTA's X-STREAM system supports an entry-level UPS function. You can use the EF DELTA AC socket while the device is connected to a wall socket with AC power supply (The AC power comes from the grid, not the battery). When the grid suddenly loses power, the device can automatically switch to EF DELTA battery power mode in  $\leq 30\text{ms}$  to ensure your work is not interrupted. Series mode is a multi-level power series solution developed based on the UPS function.

It allows users to connect two EF DELTAs in series to get continuous power that is two times more than a single machine. The principle of using it is when the power of a EF DELTA is used up, the next machine can immediately replace it to continue the power supply. This is an entry-level UPS function that does not support 0ms in switching power.

**Do not connect devices require high continuing power supply. Otherwise, please run multiple tests to confirm it's compatibility before connecting devices, such as data servers and workstations, with EF DELTA. EcoFlow do not take responsibility for any data loss or equipment damage caused by customers' failure in following the instruction.**

## 1.Entry-Level UPS user guide

Users can connect the EF DELTA AC charging cable to the power grid and connect a electricity device to EF DELTA turn on the AC switch and automatically enter the entry-level UPS mode. When the external power is cut off, battery will immediately supplied power to protect your device.

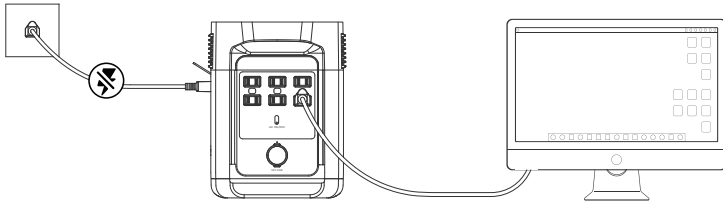

EF DELTA supports the entry-level UPS function with the switching time of less than 30ms. In accordance with the UL 2743 standard, the AC output consist of a double blade, ungrounded configuration. Hence, it is recommended to use the UPS function of EF DELTA only for temporary emergency usage rather than for long-term usage. DO NOT use electric appliances with bare metal when charging to avoid the risk of electric leakage and electric shock. It is recommended NOT to use the UPS function of EF DELTA for products such as databases, servers, etc. If you want to use the UPS function for devices that is sensitive to the switching time, please purchase a professional-grade UPS system. Please note that EcoFlow is not responsible for any potential data loss due to the use of UPS function.

## 2. Series mode user guide (Recommended for power users; all machines must be fully charged)

Users can connect no more than 2 fully-charged EF DELTAs in series using the AC charging cable to get continuous power and supply appliances with high output requirements for up to 1.8 hours. In this mode, do not connect EF DELTA to the power grid using an AC charging cable, or the overcurrent protection (<20A) may be triggered. Connect EF DELTA to a home power grid and charge each EF DELTA separately. We do not recommend you to charge more than two EF DELTA at the same time. Otherwise, the excessive load may cause damage to the home power grid. To use this function, you need to set one EF DELTA as the Master and the others as Serve 1. Connect one AC cable to the AC output port of the master unit and the other side to the input port of Serve 1. After connecting the EF DELTA, turn all the AC switches on EF DELTA on to activate multi-machine series mode. **Finally, connect all the appliances to the AC sockets of the Serve 1. Then you can charge your devices by using EF DELTA and enjoy the benefits from extended powering time.**

## Example:

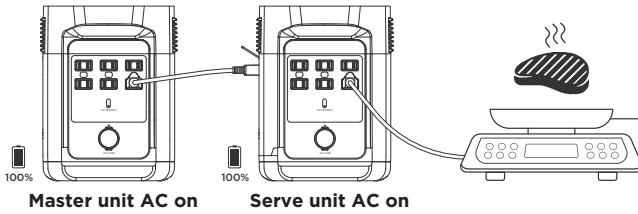

# TECHNICAL SPECIFICATIONS

## General Specs

Net Weight	30.9lbs (14kg)
Dimension	15.7 x 8.3 x 10.6in (40 x 21 x 27cm)
Capacity	1008Wh / 1260Wh (50.4V)
Testing and certification	UL CE FCC RoHS PSE

## Output

AC Output (x6)/AC Output (x4)	1800W (Surge 3300W)total, 120Vac (60Hz)/230Vac (50Hz) 1600W (Surge 3100W)total, 120Vac (60Hz)/230Vac (50Hz)
USB-A Output (x2)	5V DC, 2.4A, 12W Max, per port
USB-A Fast Charge (x2)	5V DC, 9V DC, 12V DC, 2.4A, 28W Max, per port
USB-C Output (x2)	5V DC, 9V DC, 15V DC, 20V DC, 3A, 60W Max, per port
Car Power Output (x1)	108.8W, 13.6V DC, 8A max

## Input

AC Charge Input Voltage	100-120Vac (50Hz/60Hz) ONLY! (International Version 220-240Vac ONLY!)
AC Charge Input Power (Example 1)	X-STREAM Charge 1200W max
Solar Charge Input	400W 10-65V DC 10A max
Car Charger (Example 2)	12V/24V DC 10A max

## Battery

Cell Chemistry	Lithium-ion
Cell Type	18650
Discharge Temperature	-4-140°F (-20-60°C)
Charge Temperature	32-113°F (0-45°C)
Shelf Life	1 Year (After fully charged)
Life Span	800 Cycles (60%)



# HOW TO RECHARGE EF DELTA

## Example 1 :

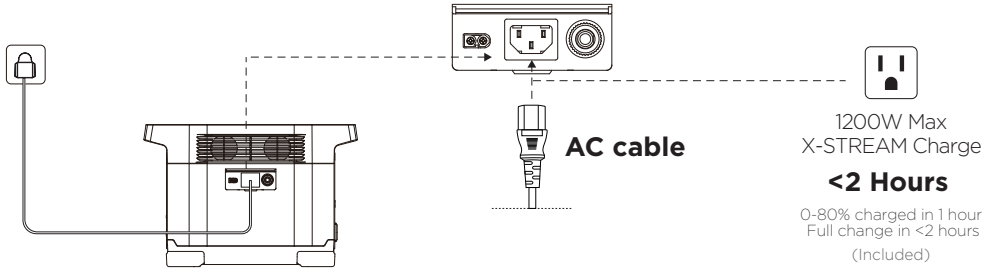

## Example 2 :

We recommend you to start the car before connect car charger to EF DELTA.

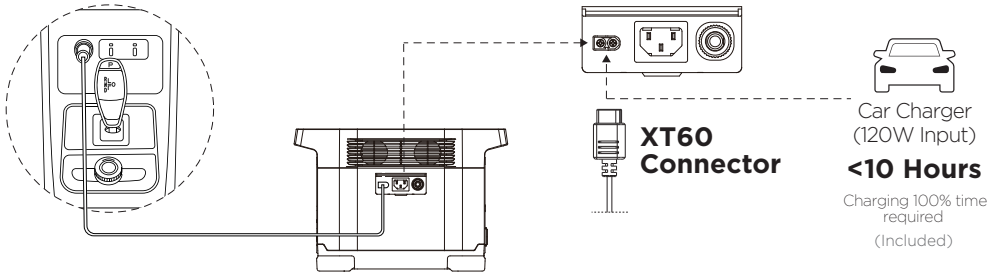

## How do I recharge my EF DELTA?

EF DELTA has an AC charging port and a XT60 charging port located on the side of EF DELTA. EF DELTA can be charged through AC power or solar panel. Besides, you can also use solar panels connect in series (no more than three) and connect the solar charge cable to the XT60 solar charging port of EF DELTA for charging.

## Can EF DELTA power my devices while it's charging?

Yes, EF DELTA can be charging and outputting power in the same time. When you are charging EF DELTA, we do not recommend connecting an electrical appliance with a power over 800w for discharging, because the current capacity of the wall outlet is limited.

## FAQs

### How do I care for EF DELTA?

EF DELTA is designed for various uses. If you need to clean EF DELTA, please use a dry and non-abrasive cloth to clean the surface. You can use cleaners designed for mobile phones or computer screens can to clean EF DELTA, but do not give it a bath!

## How do I store EF DELTA?



1. EcoFlow offers a water-resistant, dustproof case and we recommend you to use it when you plan to store your EF DELTA for a long time.
2. Make sure to recharge EF DELTA to around 85%.
3. Put EF DELTA into the case
4. Please store your EF DELTA in a dry environment without surrounded by abrasive objects. For optimal battery health, store EF DELTA in room temperature.
5. Discharge EF DELTA to 30%, then charge to 85% every 3 month. This can help prolong the battery life and ensure your EF DELTA is ready to recharge the gears at all times. Without any external sources for power supply during storage, EF DELTA has a shelf life of over a year.

## How do I use EF DELTA safely?

Please use EF DELTA in its operating temperature range. Using EF DELTA outside of its optimal operating temperature range can push the machine beyond its safe and effective limits. Do not submerge your EF DELTA in water. It is not waterproofed and this will void your warranty. If you want to protect EF DELTA against moisture and dust, use a EF DELTA protector (IP54). Do not block the ventilation Fan while using EF DELTA.

### **⚠ WARNING**

**Do not charge the machine right after it is fully discharged (E.g. 1000W keep 40mins or 1500W keep 30 mins). For your safety, please wait 2 to 3 hours for the product to cool down before charging it!**

If you attempt to charge EF DELTA immediately after a full discharge, EF DELTA will display RECHARGING TIME   as an overheating protection reminder. Please wait 2 to 3 hours for the machine to be cooled down before recharging it.

## WHAT'S IN THE BOX

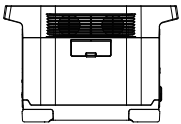

EF DELTA

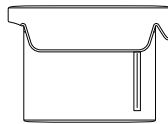

EF DELTA Bag

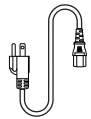

1.5m AC Cable  
(Input)

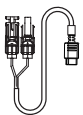

Solar Charge Cable  
(MC4 to XT60 Input)

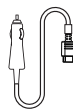

1.5m Car Charge Cable  
(Input)



User Manual &  
Warranty Card